

Data Sheet

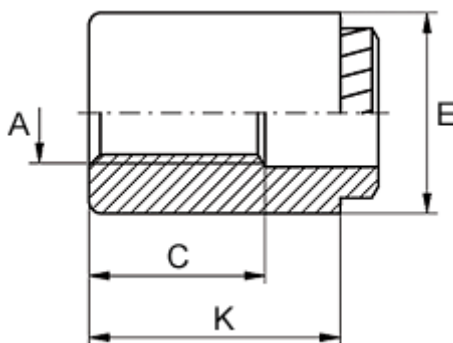

Article number: 12511600030500
Description: KLEE-coil 511 600 030.500
M3 Stainless 1.4305

Measures



Female thread A	= M3
Height K	= 11
Hole diameter +0.1	= 4.2
Min distance to edge	= 2.4
Min material thickness	= 1.5
Outer diameter E	= 7
Thread length	= 9